

# SPECIFICATION

**Customer :** \_\_\_\_\_  
**Model Name:** SAT043AT40D09RH-30671T051KN  
**ERP NO. :** 1010430248  
**Spec Vision:** V.1  
**Date:** 2019/02/21

- Preliminary Specification  
 Final Specification

Approved by	Comment

Prepared by	Reviewed by	Approved by



## Contents

1. General Specifications.....	4
2. Pin Assignment.....	5
3. Operation Specifications.....	6
3.1. Absolute Maximum Ratings.....	6
3.1.1. Recommended Operation Range.....	6
3.1.2. Backlight Driving Conditions.....	7
3.2. Power Sequence.....	8
3.2.1. Power On Sequence.....	8
3.2.2. Power Off Sequence.....	9
3.3. Timing Characteristics.....	10
3.3.1. RGB Input Timing Table.....	10
3.3.2. Timing Diagram.....	11
4. Optical Specifications.....	14
5. Reliability Test Items.....	15
6. Mechanical Drawing.....	16
7. Package Drawing.....	17
8. Numbering System.....	18

# 1. General Specifications

NO.	Item	Specification	Remark
1	Panel Size	4.3 inch(Diagonal)	
2	Resolution	480 x 3(RGB) x 272	
3	Driver Method	A-Si TFT active matrix	
4	Active Area	95.04(W) x 53.856(H) mm	
5	Dot Pitch	0.198(W) x 0.198(H) mm	
6	Pixel Arrangement	RGB-stripe	
7	Module Size	105.5(W) x 67.2(H) x3.0(D) mm	
8	Display Mode	Normally White	
9	Display Color	16.7M	
10	Viewing Direction	6 o'clock	
11	Interface	TTL RGB-24Bit parallel interface	
12	Driving IC	ST7282	
13	Weight	TBD	g

## 2. Pin Assignment

No.	Symbol	Function	Remarks
1	VLED-	Power for LED backlight (Cathode)	
2	VLED+	Power for LED backlight (anode)	
3	GND	Power ground	
4	VDD	Power for digital circuit	
5-12	R0~R7	Red data	
13-20	G0~G7	Green data	
21~28	B0~B7	Blue data	
29	GND	Power ground	
30	PCLK	Pixel clock	
31	DISP	Display ON/OFF	
32	HSYNC	Horizontal Sync input	
33	VSYNC	Vertical Sync input	
34	DE	Data input enable	
35	NC	No connection	
36	GND	Power ground	
37	XR	Right electrode-differential analog	When this pin not used,please leave it open
38	YD	Bottom electrode-differential analog	
39	XL	Left electrode-differential analog	
40	YU	Top electrode-differential analog	

### 3. Operation Specifications

#### 3.1. Absolute Maximum Ratings

Voltage (AGND=GND=0V, Ta = 25°C)

Parameter	Min.	Max.	Unit
Power Supply Voltage V <sub>DD</sub>	-0.3	+4.6	V
I/O Supply Voltage V <sub>DDI</sub>	-0.3	+4.6	V
Charge Pump Supply Voltage P <sub>VDD</sub>	-0.3	+4.6	V
Storage Temperature	-0.3	+4.6	V
Operating Temperature	-20	70	°C
Storage Temperature	-30	80	°C

**Note:** The absolute maximum rating values of this product are not allowed to be exceeded at any times. Should a module be used with any of the absolute maximum ratings case ,the module may be permanently destroyed.

##### 3.1.1. Recommended Operation Range

Parameter	Symbol	values			Unit
		Min.	Typ.	Max.	
Digital Supply Voltage	V <sub>DD</sub>	3.0	3.3	3.6	V
I/O Supply Voltage	V <sub>DDI</sub>	1.65	-	V <sub>DD</sub>	V
Charge Pump Supply	P <sub>VDD</sub>	3.0	3.3	3.6	V
Positive High-Voltage power	V <sub>GH</sub>	13	15	17.5	V
Negative High-Voltage power	V <sub>GL</sub>	-11.5	-10	-7	V
Standby Current	I <sub>sc</sub>	-	-	50	uA
Operation Current	I <sub>oc</sub>	-	20	-	mA

**3.1.2. Backlight Driving Conditions**

Parameter	Symbol	Min.	Typ.	Max.	Unit
Supply voltage of white LED backlight	V <sub>L</sub>	27.0	27.9	29.7	V
Current for LED backlight	I <sub>L</sub>	15	20	25	mA
Luminance (on the module surface ,BM-7)		350	400	-	cd/m <sup>2</sup>
LED life time	-	50000	-	-	Hr

## 3.2. Power Sequence

### 3.2.1. Power On Sequence

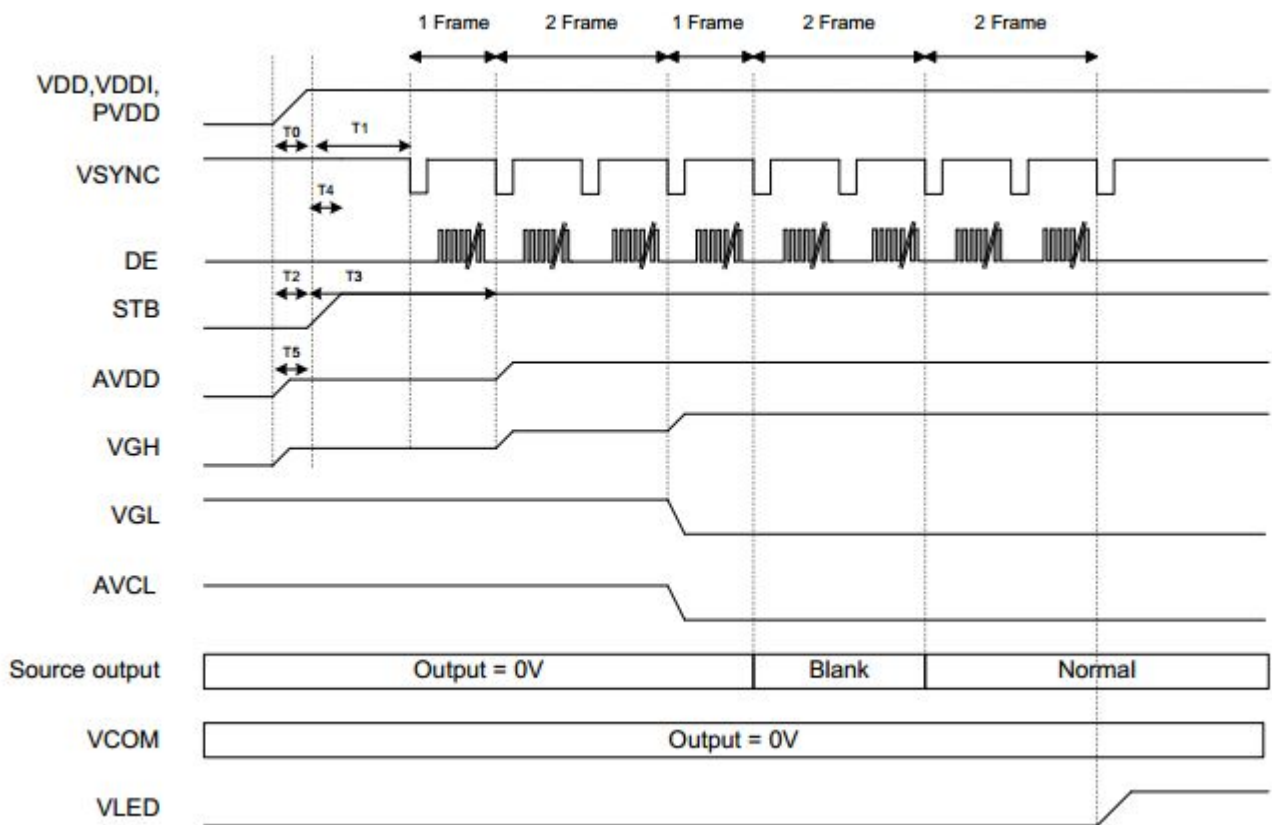

	Description	Min. Time
T0	Determined by the external power	
T1	Time from stable VDD, VDDI, PVDD set-up to the first VSYNC	T1=0
T2	Time from AVDD=0V to AVDD=3.3V	T2=T0
T3	Time from AVDD=3.3V to AVDD=6.0V	T3=T1+ (1*Frame)
T4	Time from stable VDD, VDDI, PVDD set-up to DISP asserted	T4=0
T5	Time from VGH=0V to VGH=3.3V	T5=T0

Note: Recommend the LCM power on rise time T0= 0~ 1ms



### 3.2.2. Power Off Sequence

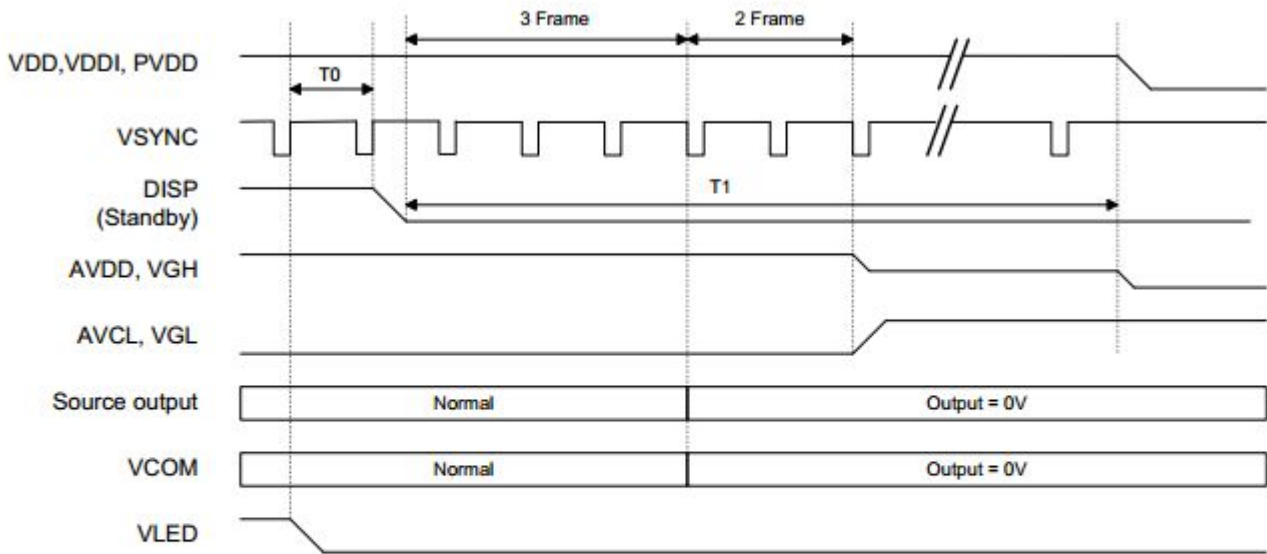

	Description	Min. Time
T0	Time from backlight power off to DISP="L"	1*Frame
T1	Time from DISP="L" to LCM Power off	5*Frame

### 3.3. Timing Characteristics

#### 3.3.1. RGB Input Timing Table

Parallel 24-bit RGB Timing Table

(PVDD=VDD=VDDI=3.3V,AGND=0V,TA=25 °C)

Item	Symbol	Min.	Typ.	Max.	Unit	Remark	
DCLK Frequency	Fclk	8	9	12	MHz		
DCLK Period	Tclk	83	111	125	ns		
HSYNC	Period Time	Th	485	531	598	DCLK	
	Display Period	Thdisp		480		DCLK	
	Back Porch	Thbp	3	43	43	DCLK	By H_Blanking setting
	Front Porch	Thfp	2	8	75	DCLK	
	Pulse Width	Thw	2	4	75	DCLK	
VSYNC	Period Time	Tv	276	292	321	H	
	Display Period	Tvdisp		272		H	
	Back Porch	Tvbp	2	12	12	H	By V_Blanking setting
	Front Porch	Tvfp	2	8	37	H	
	Pulse Width	Tvw	2	4	37	H	

Note: It is necessary to keep Tvbp =12 and Thbp =43 in sync mode. DE mode is unnecessary to keep it.

Serial 8-bit RGB Timing Table

Item	Symbol	Min.	Typ.	Max.	Unit	Remark	
DCLK Frequency	Fclk	24	27	30	MHz		
DCLK Period	Tclk	33	37	42	ns		
HSYNC	Period Time	Th	1445	1491	1558	DCLK	
	Display Period	Thdisp		1440		DCLK	
	Back Porch	Thbp	3	43	43	DCLK	By H_Blanking setting
	Front Porch	Thfp	2	8	75	DCLK	
	Pulse Width	Thw	2	4	75	DCLK	
VSYNC	Period Time	Tv	276	292		H	
	Display Period	Tvdisp		272		H	
	Back Porch	Tvbp	2	12	12	H	By V_Blanking setting
	Front Porch	Tvfp	2	8	37	H	
	Pulse Width	Tvw	2	4	37	H	

Note: It is necessary to keep Tvbp =12 and Thbp =43 in sync mode. DE mode is unnecessary to keep it.

### 3.3.2. Timing Diagram

#### SYNC Mode Timing Diagram

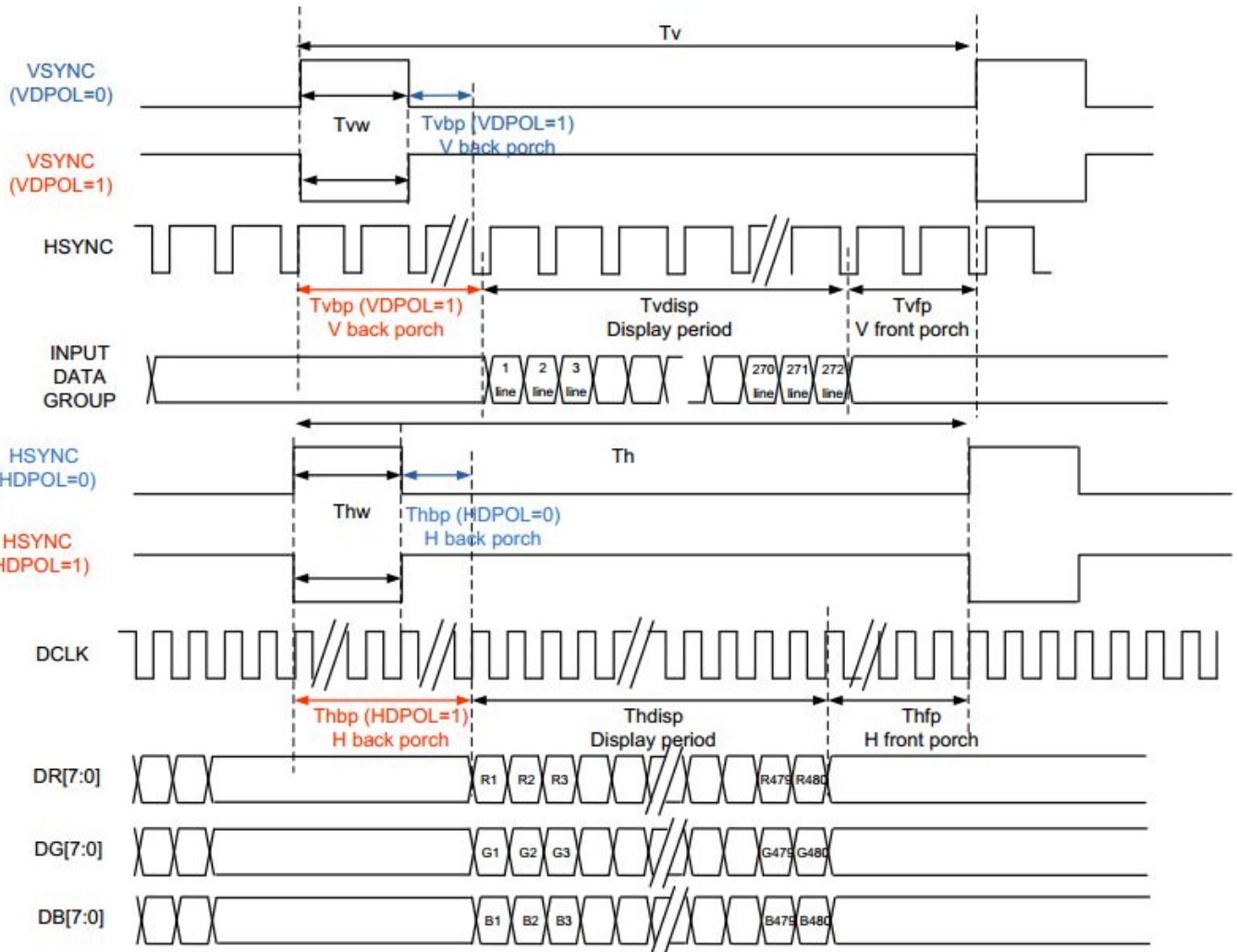

### SYNC-DE Mode Timing Diagram

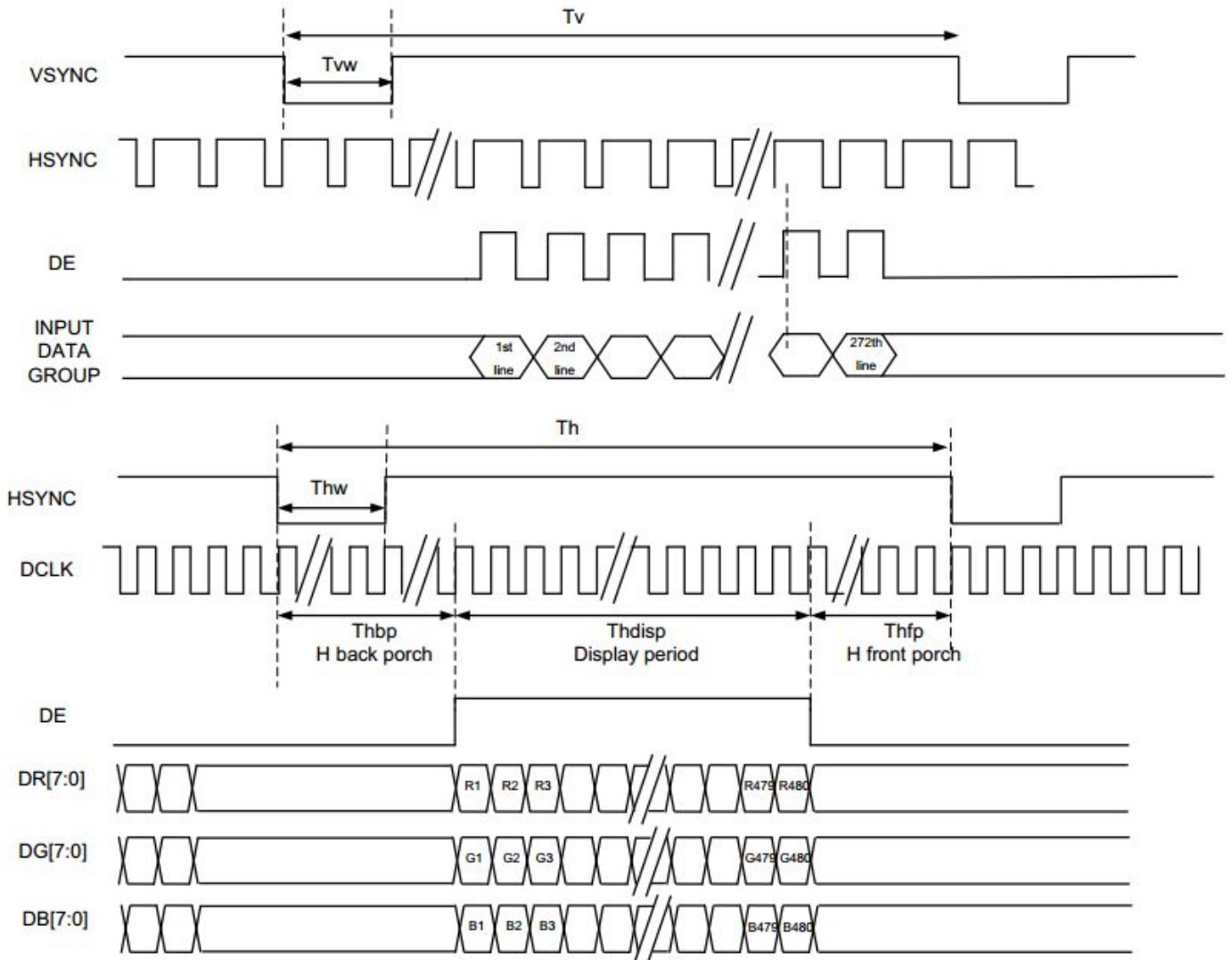

## DE Mode Timing Diagram

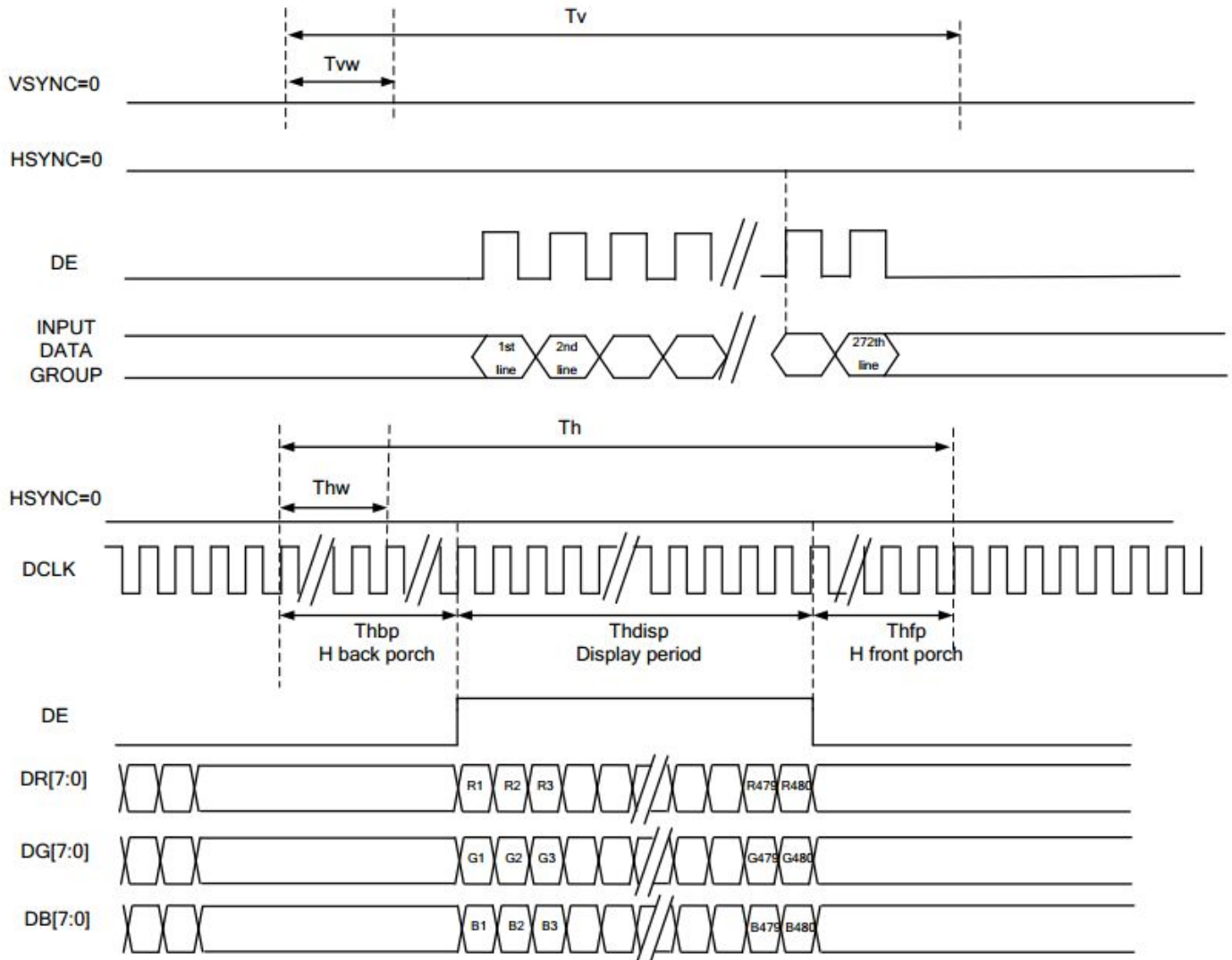

## 4. Optical Specifications

Item		Symbol	Min.	Typ.	Max.	Unit	Note
Contrast Ratio		CR	300	500	-	-	
Color gamut (NTSC ratio)		-	-	52	-	%	
Response Time		Rising + Falling	-	25	50	ms	
Viewing Angle	Horizontal	$\theta_{x^+}$	50	60	-	degree	
		$\theta_{x^-}$	50	60	-		
	Vertical	$\theta_{y^+}$	30	40	-		
		$\theta_{y^-}$	40	50	-		
Color Filter Chromaticity (CIE1931)	Red	X	-0.02	0.618	+0.02	-	
		Y		0.343			
	Green	X		0.306			
		Y		0.527			
	Blue	X		0.139			
		Y		0.098			
	White	X		0.300			
		Y		0.350			
Luminance (center)		L	350	400	-	cd/m <sup>2</sup>	
Luminance Uniformity		$\Delta L$	75	80		%	

### Test Condition:

- 1、VDD=3.3V,IL=20mA(Backlight current), the ambient temperature is 25°C.

## 5. Reliability Test Items

Item	Test Conditions	Remark
High Temperature Storage	Ta=80°C 120h	Note1 ,Note4
Low Temperature Storage	Ta=-30°C 120h	Note1, Note4
High Temperature Operation	Ts=70°C 120h	Note2 ,Note4
Low Temperature Operation	Ts=-20°C 120h	Note4
Operation at High Temperature and Humidity	+60°C,90%RH 120h	Note4
Thermal Shock	-20°C/30min~+70°C/30min for a total 100 cycles , Start with cold temperature and end with high temperature	
Package Drop Test	Height 60cm 1corner , 3edges , 6surfaces	
Elector Static Discharge	±2KV,Human Body Mode, 150pF/330 Ω	

Note1: Ta is the ambient temperature of samples.

Note2: Ts is the temperature of panel's surfaces.

Note3: In the standard condition, there shall be no practical problem that may affect the display function. After the reliability test, the product only guarantees operation, but doesn't guarantee all of the cosmetic specification.

Note4: before cosmetic and function test, the product must have enough recovery time, at least 2 hours at room temperature.







## 7. Package Drawing

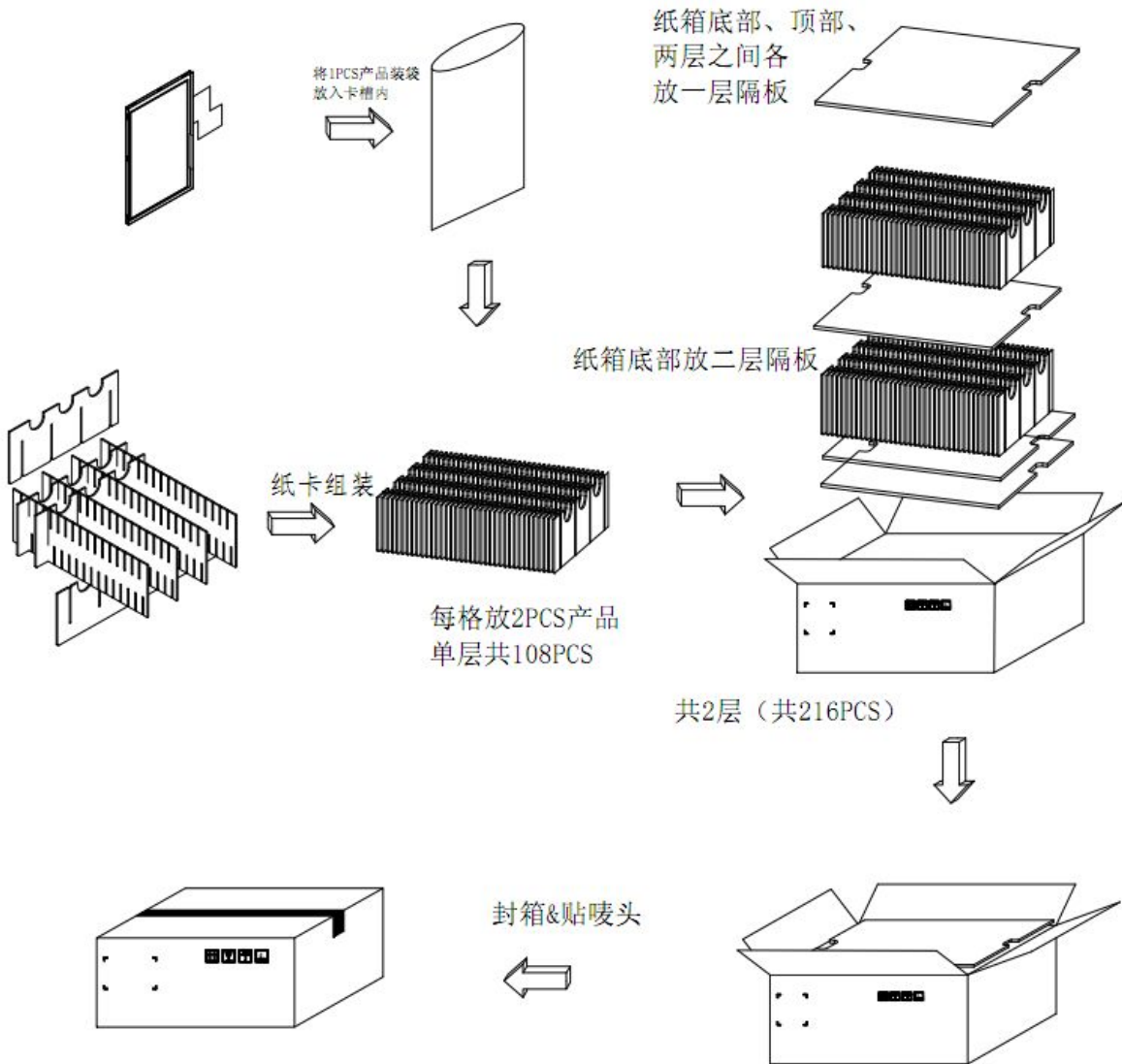

## 8. Numbering System

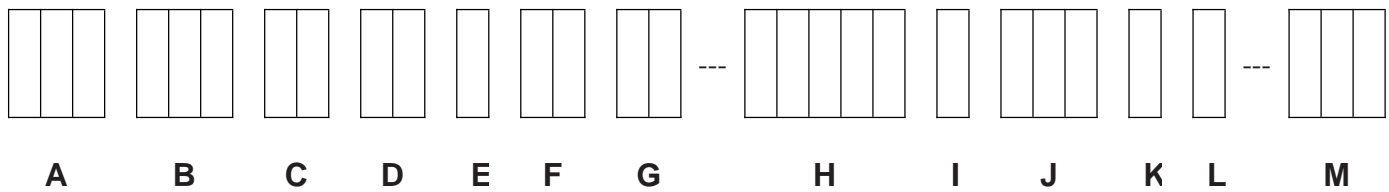

NO.	Definition	Specifications
A	LCM Product NO.	SAT INTERNATIONAL CO.LTD.
B	Display monitor opposite angle line size	Unit : inch (size<10inch:take two integers;size>=10inch:takes three integers)
C	LCD Brands	AU-AUO; CP-CPT; IV-IVO; TM-TIANMA; HS-HSD; CM-CMO; BO-BOE; AT--INNOLUX;
D	Interface PIN Number	Arabic numerals from 01 to 99
E	LCD Type	A--Alternated Video Signal; D--Data Video Signal; H--High Definition ; I--IPS
F	Backlight LED Number	Arabic numerals from 01 to 99
G	Backlight Color Are	Include R1、R2、Y0、Y1、B1、B2;
H	Structure Size	Include module length and width size
I	Interface Mode	T:TTL L:LVDS M:MIPI
J	FPC Length	It represents the length of FPC with three figures, divided into long rows ,middle rows and short rows
K	View Angles	Z : represent narrow viewing angle K : represent wide viewing angle I : represent all viewing angle
L	Operating Mode	D: DE mode V: VSD mode F: Inverting mode N: No mode requirements
M	Suffix	1. NULL ; 2. TP/CTP-- Touch panel; 3. other--Insignificance