

MP6752

High Power Switching Applications
 Motor Control Applications

- The electrodes are isolated from case.
- 6 IGBTs are built into 1 package.
- Enhancement-mode
- Low saturation voltage
 : $V_{CE(sat)} = 4.0V$ (max.) ($I_C = 20A$)
- High speed: $t_f = 0.35\mu s$ (max.) ($I_C = 20A$)
 $t_{rr} = 0.15\mu s$ (max.) ($I_F = 20A$)

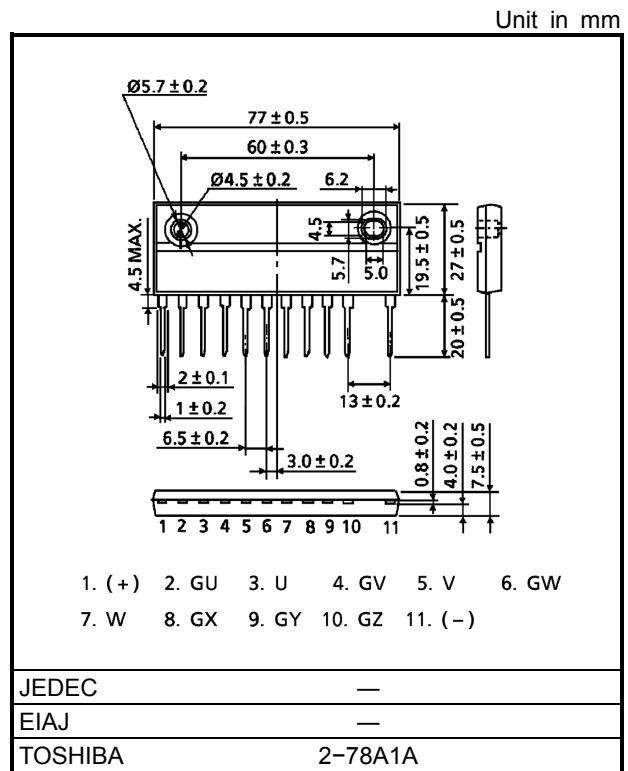

Weight: 44g

Equivalent Circuit

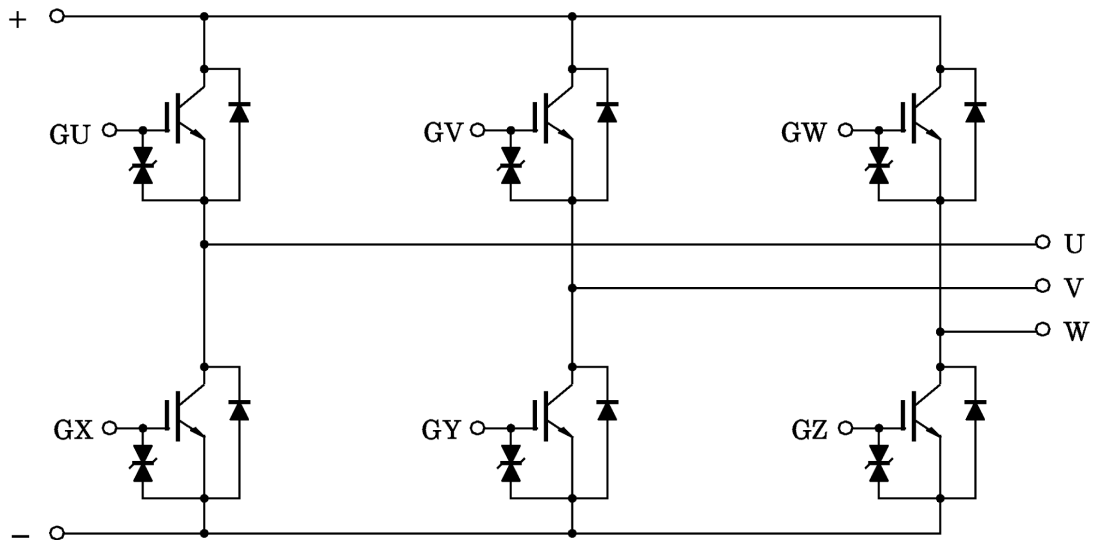

Maximum Ratings (Ta = 25°C)

Characteristic		Symbol	Rating	Unit
Collector-emitter voltage		V_{CES}	600	V
Gate-emitter voltage		V_{GES}	±20	V
Collector current	DC	I_C	20	A
	1ms	I_{CP}	40	
Forward current	DC	I_F	20	A
	1ms	I_{FM}	40	
Collector power dissipation (Tc = 25°C)		P_C	60	W
Junction temperature		T_j	150	°C
Storage temperature range		T_{stg}	-40~125	°C
Isolation voltage		V_{isol}	2500 (AC 1 minute)	V
Screw torque		—	1.5	N·m

Electrical Characteristics (Ta = 25°C)

Characteristic		Symbol	Test Condition	Min.	Typ.	Max.	Unit
Gate leakage current		I_{GES}	$V_{GE} = \pm 20V, V_{CE} = 0$	—	—	±20	μA
Collector cut-off current		I_{CES}	$V_{CE} = 600V, V_{GE} = 0$	—	—	1.0	mA
Gate-emitter cut-off voltage		$V_{GE(off)}$	$I_C = 20mA, V_{CE} = 5V$	3.0	—	6.0	V
Collector-emitter saturation voltage		$V_{CE(sat)}$	$I_C = 20A, V_{GE} = 15V$	—	3.0	4.0	V
Input capacitance		C_{ies}	$V_{CE} = 10V, V_{GE} = 0, f = 1MHz$	—	1300	—	pF
Switching time	Rise time	t_r		—	0.3	0.6	μs
	Turn-on time	t_{on}		—	0.4	0.8	
	Fall time	t_f		—	0.2	0.35	
	Turn-off time	t_{off}		—	0.5	1.0	
Forward voltage		V_F	$I_F = 20A, V_{GE} = 0$	—	1.7	2.5	V
Reverse recovery time		t_{rr}	$I_F = 20A, V_{GE} = -10V, di/dt = 50A/\mu s$	—	0.08	0.15	μs
Thermal resistance	$R_{th(j-c)}$	Transistor	—	—	2.08	°C/W	
		Diode	—	—	3.09		

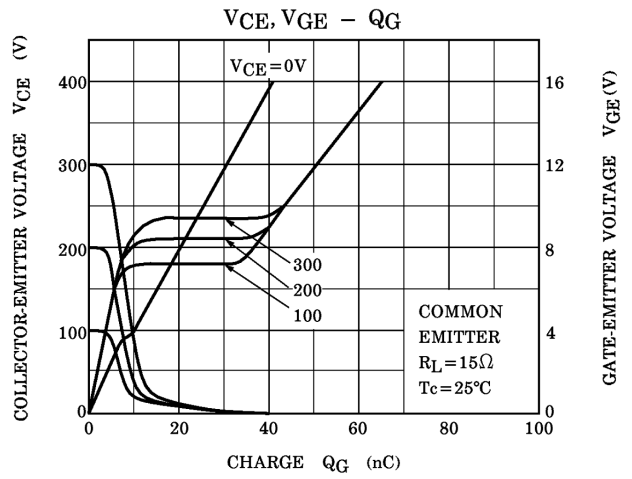
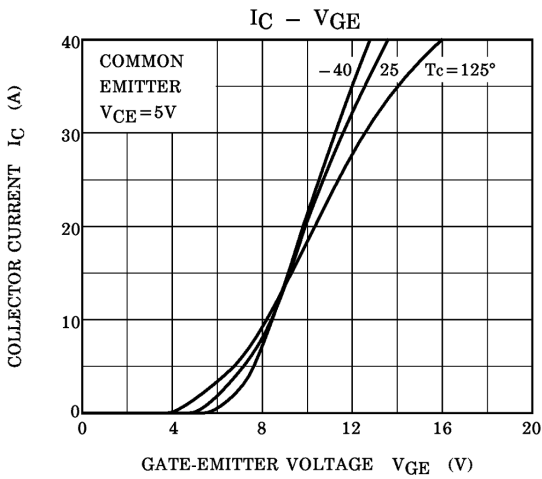
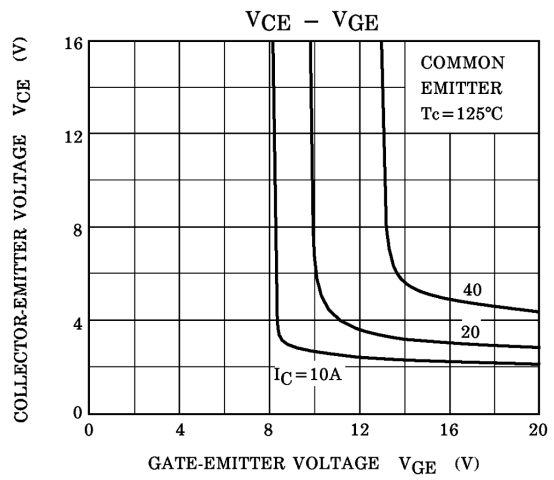
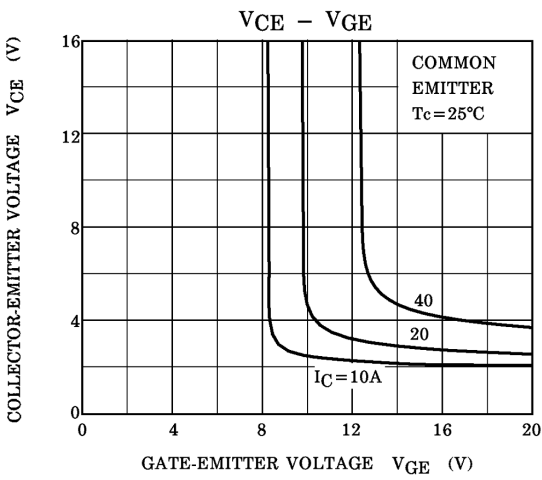
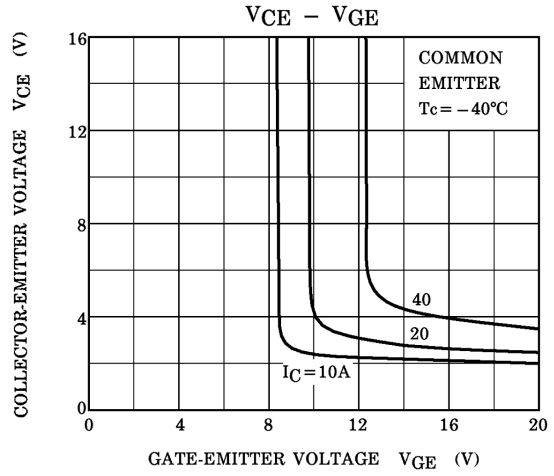
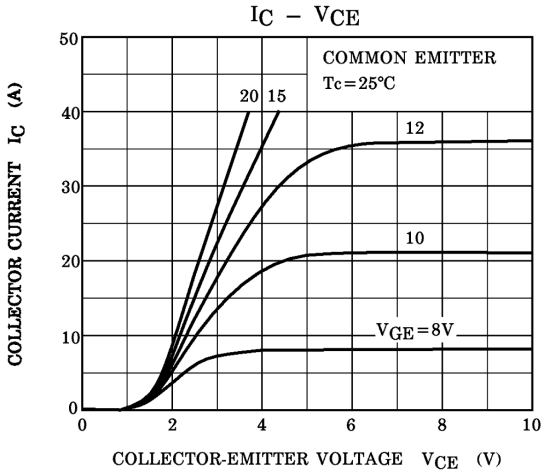

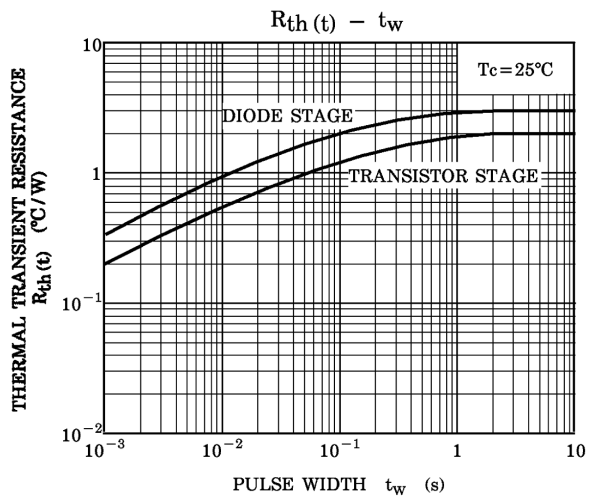
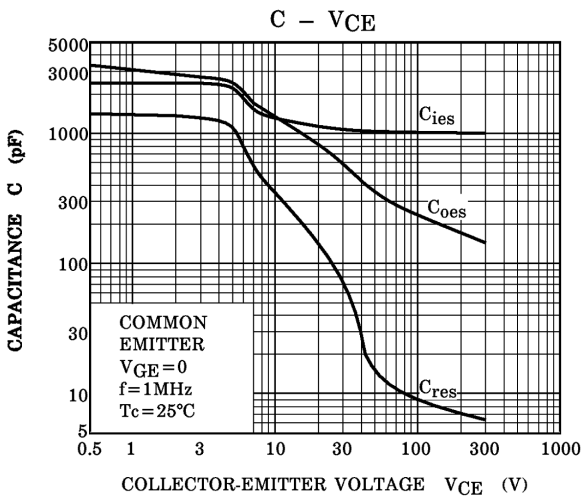
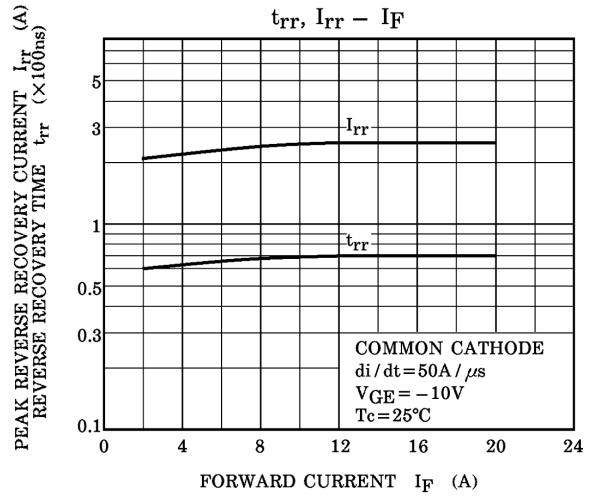
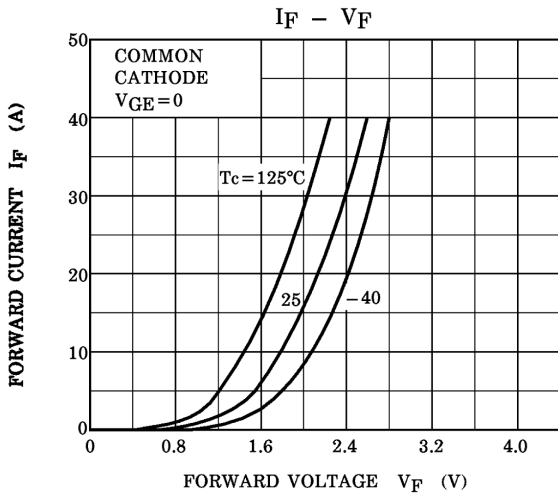
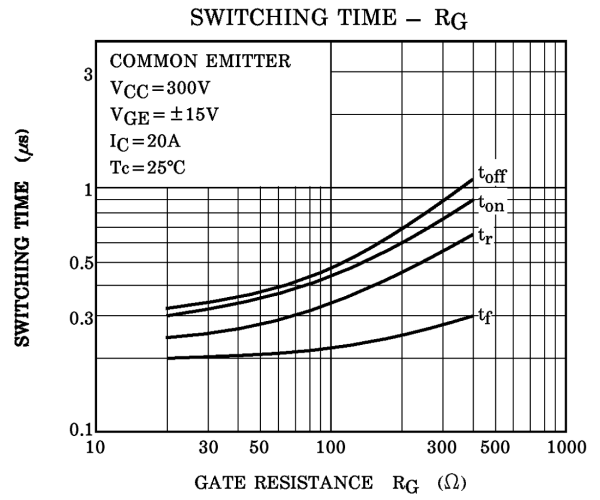
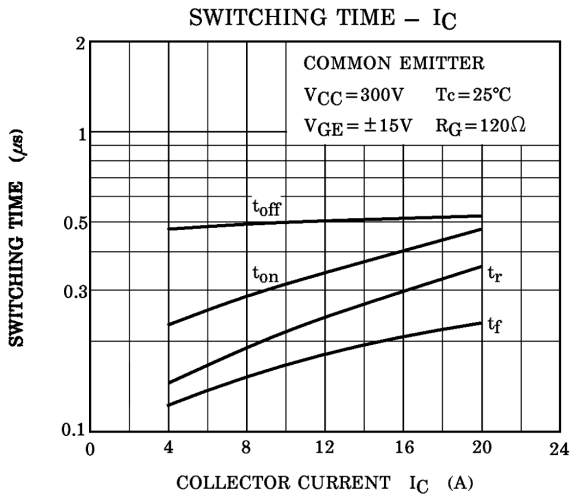

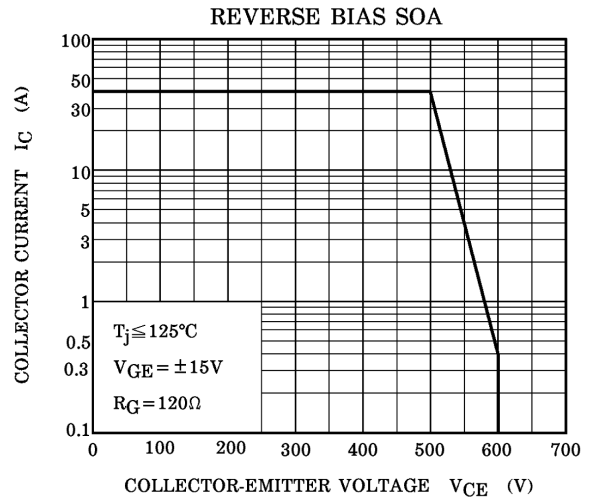
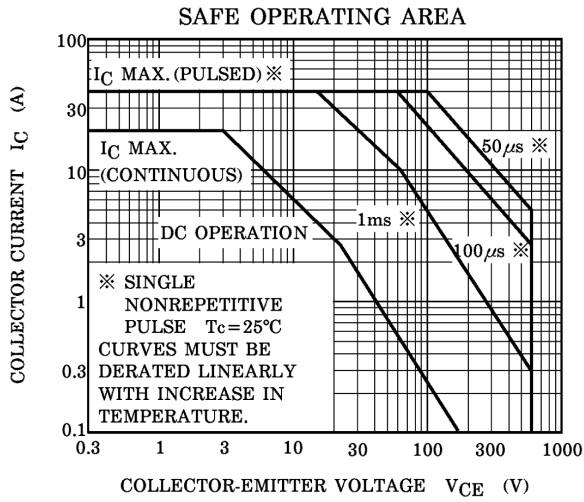

RESTRICTIONS ON PRODUCT USE

000707EAA

- TOSHIBA is continually working to improve the quality and reliability of its products. Nevertheless, semiconductor devices in general can malfunction or fail due to their inherent electrical sensitivity and vulnerability to physical stress. It is the responsibility of the buyer, when utilizing TOSHIBA products, to comply with the standards of safety in making a safe design for the entire system, and to avoid situations in which a malfunction or failure of such TOSHIBA products could cause loss of human life, bodily injury or damage to property.
In developing your designs, please ensure that TOSHIBA products are used within specified operating ranges as set forth in the most recent TOSHIBA products specifications. Also, please keep in mind the precautions and conditions set forth in the "Handling Guide for Semiconductor Devices," or "TOSHIBA Semiconductor Reliability Handbook" etc..
- The TOSHIBA products listed in this document are intended for usage in general electronics applications (computer, personal equipment, office equipment, measuring equipment, industrial robotics, domestic appliances, etc.). These TOSHIBA products are neither intended nor warranted for usage in equipment that requires extraordinarily high quality and/or reliability or a malfunction or failure of which may cause loss of human life or bodily injury ("Unintended Usage"). Unintended Usage include atomic energy control instruments, airplane or spaceship instruments, transportation instruments, traffic signal instruments, combustion control instruments, medical instruments, all types of safety devices, etc.. Unintended Usage of TOSHIBA products listed in this document shall be made at the customer's own risk.
- The information contained herein is presented only as a guide for the applications of our products. No responsibility is assumed by TOSHIBA CORPORATION for any infringements of intellectual property or other rights of the third parties which may result from its use. No license is granted by implication or otherwise under any intellectual property or other rights of TOSHIBA CORPORATION or others.
- The information contained herein is subject to change without notice.