

NCP81074A, NCP81074B

Single Channel 10A High Speed Low-Side MOSFET Driver

The NCP81074 is a single channel, low-side MOSFET driver. It is capable of providing large peak currents into capacitive loads. This driver can deliver a 7 A peak current at the Miller plateau region to help reduce the Miller effect during MOSFETs switching transitions. It exhibits a split output configuration allowing the user to control the turn on and turn off slew rates. This part is available in SOIC-8 and DFN8 2x2 mm packages.

Features

- High Current Drive Capability ± 10 A
- TTL/CMOS Compatible Inputs Independent of Supply Voltage
- High Reverse Current Capability (10 A) Peak
- 4 ns Typical Rise and 4 ns Typical Fall Times with 1.8 nF Load
- Fast Propagation Delay Times of 15 ns with Input Falling and 15 ns with Input Rising
- Input Voltage Range from 4.5 V to 20 V
- Split Output Configuration
- Dual Input Design Offering Drive Flexibility
- These Devices are Pb-Free, Halogen Free/BFR Free and are RoHS Compliant

Applications

- Server Power
- Telecommunication, Datacenter Power
- Synchronous Rectifier
- Switch Mode Power Supply
- DC/DC Converter
- Power Factor Correction
- Motor Drive
- Renewable Energy, Solar Inverter



ON Semiconductor®

www.onsemi.com

MARKING DIAGRAMS

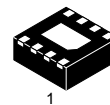

DFN8
MN SUFFIX
CASE 506AA

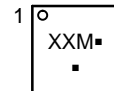

XX = Specific Device Code
M = Date Code
▪ = Pb-Free Device

(Note: Microdot may be in either location)

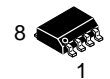

SOIC-8
CASE 751

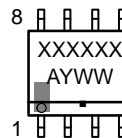

XXXXXX = Specific Device Code
A = Assembly Location
Y = Year
WW = Work Week
▪ = Pb-Free Package

ORDERING INFORMATION

See detailed ordering, marking and shipping information on page 2 of this data sheet.

NCP81074A, NCP81074B

ORDERING INFORMATION

Device	Temperature Range (°C)	Marking	Input Type	Package Type	Shipping†
NCP81074AMNTBG	-40 to +140	CL	Fixed Digital Threshold	DFN8 2x2 (Pb-Free)	3000 / Tape & Reel
NCP81074BMNTBG	-40 to +140	CM	VDD Based Threshold	DFN8 2x2 (Pb-Free)	3000 / Tape & Reel
NCP81074ADR2G	-40 to +140	NCP81074A	Fixed Digital Threshold	SOIC-8 (Pb-Free)	2500 / Tape & Reel
NCP81074BDR2G	-40 to +140	NCP81074B	VDD Based Threshold	SOIC-8 (Pb-Free)	2500 / Tape & Reel

†For information on tape and reel specifications, including part orientation and tape sizes, please refer to our Tape and Reel Packaging Specifications Brochure, BRD8011/D.

BLOCK DIAGRAM

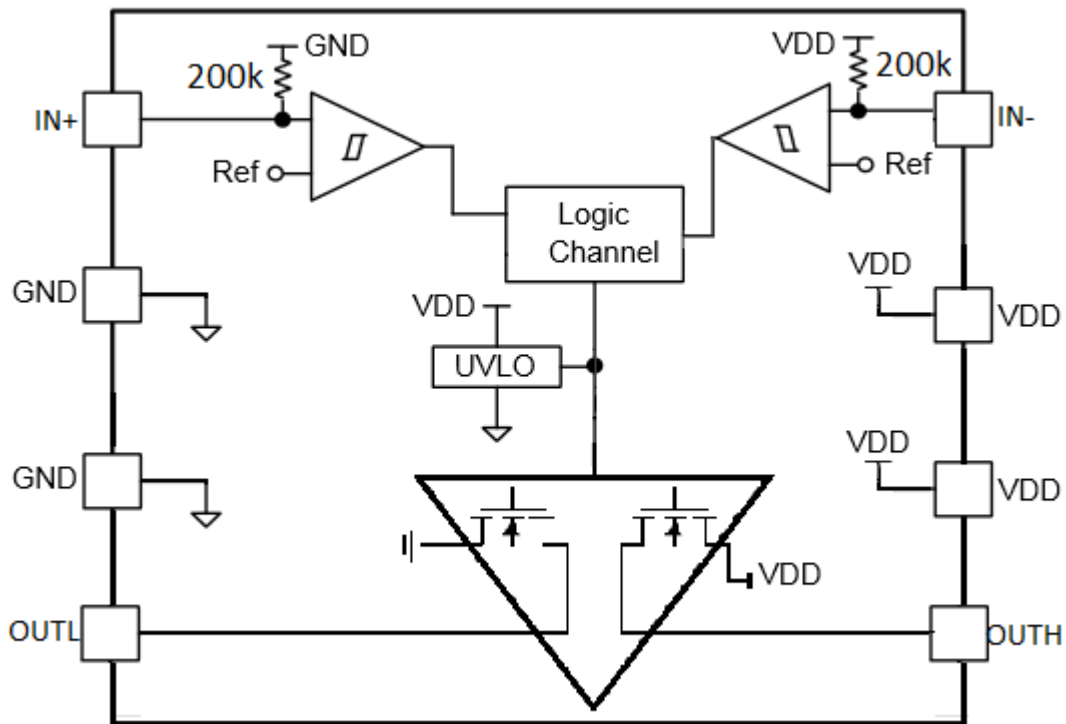

Figure 1. NCP81074 Block Diagram

NCP81074A, NCP81074B

PIN DESCRIPTION

Pin No.	Symbol	Description
1	IN+	Non-Inverting Input which has logic compatible threshold and hysteresis. If not used, this pin should be connected to either VDD or GND. It should not be left unconnected.
2	GND	Common ground. This ground should be connected very closely to the source of the power MOSFET.
3	GND	Common ground. This ground should be connected very closely to the source of the power MOSFET.
4	OUTL	Sink pin. Connect to Gate of MOSFET.
5	OUTH	Source Pin. Connect to Gate of MOSFET.
6	VDD	Power Supply Input Pin.
7	VDD	Power supply Input Pin.
8	IN-	Inverting Input which has logic compatible threshold and hysteresis. If not used, this pin should be connected to either VDD or GND. It should not be left unconnected

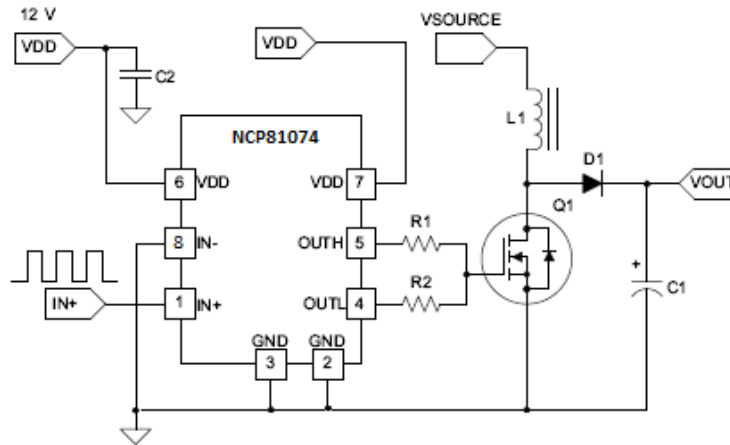

Figure 2. TYPICAL APPLICATION CIRCUIT

ABSOLUTE MAXIMUM RATINGS

Parameter		Value		Unit
		Min	Max	
Supply Voltage	VDD	-0.3	24	V
Output Current (DC)	I _{out_dc}	0.6		A
Reverse Current (Pulse<1 μs)			10	A
Output Current (Pulse<0.5 μs)	I _{out_pulse}	10		A
Input Voltage	IN+, IN-	-6	24	V
Output Voltages	OUTH, OUTL	-0.3	VDD + 0.3	V
Output Voltages (Pulse<0.5 μs)	OUTH, OUTL	-3.0	VDD + 3.0	V
Junction Operation Temperature	T _J	-40	150	°C
Storage Temperature	T _{stg}	-65	160	
Electrostatic Discharge	Human body model, HBM	4000		V
	Charge device model, CDM	1000		
OUT Latch-up Protection		500		mA
Moisture Sensitivity Level (MSL)		MSL1		

Stresses exceeding those listed in the Maximum Ratings table may damage the device. If any of these limits are exceeded, device functionality should not be assumed, damage may occur and reliability may be affected.

NCP81074A, NCP81074B

RECOMMENDED OPERATING CONDITIONS

Parameter	Rating	Unit
VDD supply Voltage	4.5 to 20	V
IN+, IN- input voltages	-5 to 20	V
Junction Temperature Range	-40 to +140	°C

Functional operation above the stresses listed in the Recommended Operating Ranges is not implied. Extended exposure to stresses beyond the Recommended Operating Ranges limits may affect device reliability.

Table 1. THERMAL INFORMATION

Package	Theta JA (°C/W)	Theta JC (°C/W)
DFN-8 2x2	80.3	11.9
SOIC-8	115	50

Table 2. ELECTRICAL CHARACTERISTICS (Note 1) (Typical values: V_{DD} = 12V, 1uF from VDD to GND, T_A = T_J = -40°C to 140°C, typical at T_{AMB} = 25°C, unless otherwise specified)

Parameter	SYMBOL	Test Conditions	MIN	TYP	MAX	Unit
SUPPLY VOLTAGE						
VDD Under Voltage Lockout (rising)	V _{CCR}	VDD rising	3.7	3.9	4.1	V
VDD Under Voltage Lockout (Falling)	V _{CCF}	VDD falling	3.4	3.6	3.8	V
VDD Under Voltage Lockout (hysteresis)	V _{CCH}			300		mV
Operating Current (no switching)	I _{DD}			1.2	2	mA
VDD Under Voltage Lockout to Output Delay (Note 1)		VDD rising		10		µs
INPUTS						
NCP81074A High Threshold	V _{thH}	Input rising from logic low	1.9	2.1	2.3	V
NCP81074A Low Threshold	V _{thL}	Input falling from logic high	1.1	1.3	1.5	V
VIN_HYS	Input Signal Hysteresis			0.8		V
NCP81074B High Threshold	V _{thH}	Input rising from logic low (VDD = 8 V to 12 V)	VDD -3.5	VDD -3.1	VDD -2.7	V
NCP81074B Low Threshold	V _{thL}	Input falling from logic high (VDD = 8 V to 12 V)	GND +2.6	GND +2.9	GND +3.2	V
IN- Pull-up Resistor	R _{in-}			200		kΩ
IN+ Pull-Down Resistor	R _{in+}			200		kΩ
OUTPUTS						
Output Resistance High	R _{OH}	I _{OUT} = -10 mA		0.4	0.8	Ω
Output Resistance Low	R _{OL}	I _{OUT} = +10 mA		0.4	0.8	Ω
Peak Source Current ⁽²⁾	I _{Source}	OUT = GND 200 ns Pulse		10		A
Miller Plateau Source Current ⁽²⁾	I _{Source}	OUT = 5.0 V 200 ns Pulse		7		A
Peak Sink Current ⁽²⁾	I _{Sink}	OUT = VDD 200 ns Pulse		10		A
Miller Plateau Sink Current ⁽²⁾	I _{Sink}	OUT = 5.0 V 200 ns Pulse		7		A

NCP81074A, NCP81074B

Table 2. ELECTRICAL CHARACTERISTICS (Note 1) (Typical values: $V_{DD}=12V$, $1\mu F$ from V_{DD} to GND , $T_A = T_J = -40^{\circ}C$ to $140^{\circ}C$, typical at $T_{AMB} = 25^{\circ}C$, unless otherwise specified)

Parameter	SYMBOL	Test Conditions	MIN	TYP	MAX	Unit
SWITCHING CHARACTERISTICS						
Propagation Delay Time Low to High, IN Rising (IN to OUT) (Note 2)	t_{d1}	$C_{Load} = 1.8\text{ nF}$		15	27	ns
Propagation Delay Time High to Low, IN Falling (IN to OUT) (Note 2)	t_{d2}	$C_{Load} = 1.8\text{ nF}$		15	27	ns
Rise Time (Note 2)	t_r	$C_{Load} = 1.8\text{ nF}$		4	7	ns
Fall Time (Note 2)	t_f	$C_{Load} = 1.8\text{ nF}$		4	7	ns

Product parametric performance is indicated in the Electrical Characteristics for the listed test conditions, unless otherwise noted. Product performance may not be indicated by the Electrical Characteristics if operated under different conditions.

1. All Limits are 100% tested at $T_{AMB} = 25^{\circ}C$ and guaranteed across temperature by design and statistical analysis.
2. Guaranteed by characterization. *See timing Waveforms.

Table 3. LOGIC TRUTH TABLE

IN+	IN-	OUTH	OUTL	OUT (OUTH & OUTL CONNECTED TOGETHER)
L	L	HIGH-Z	L	L
L	H	HIGH-Z	L	L
H	L	H	HIGH-Z	H
H	H	HIGH-Z	L	L

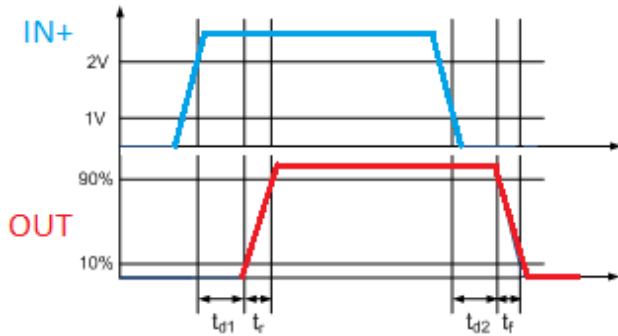

Figure 3. Non-inverting Input Driver Operation

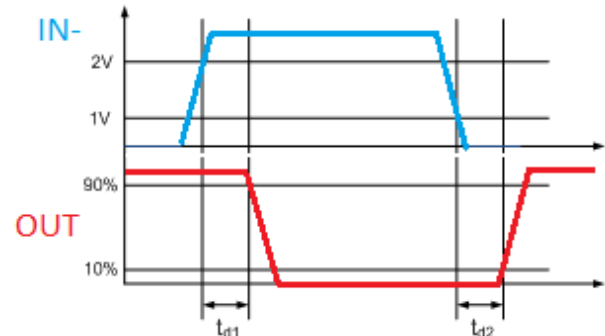

Figure 4. Inverting Input Driver Operation

NCP81074A, NCP81074B

TYPICAL CHARACTERISTICS

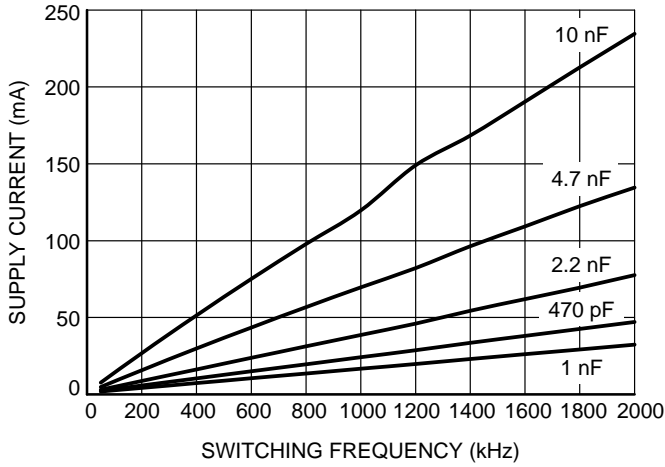

Figure 5. Supply Current vs. Switching Frequency, $V_{DD} = 12\text{ V}$

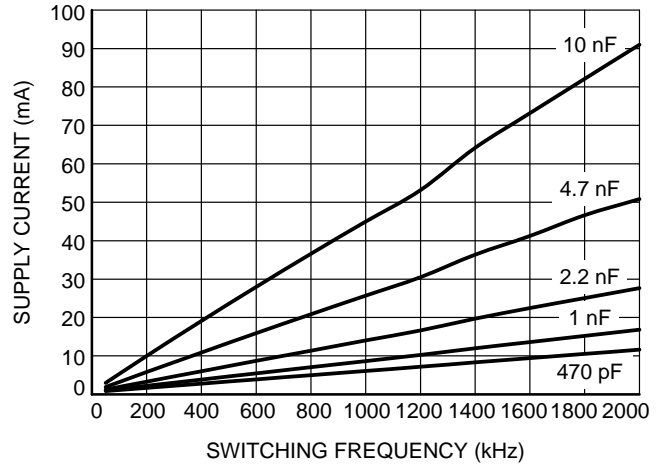

Figure 6. Supply Current vs. Switching Frequency, $V_{DD} = 4.5\text{ V}$

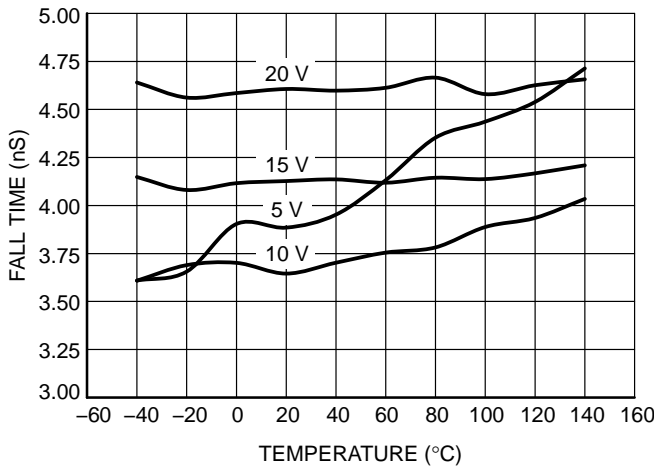

Figure 7. Fall Time vs. Temperature
 $C_{LOAD} = 1.8\text{ nF}$

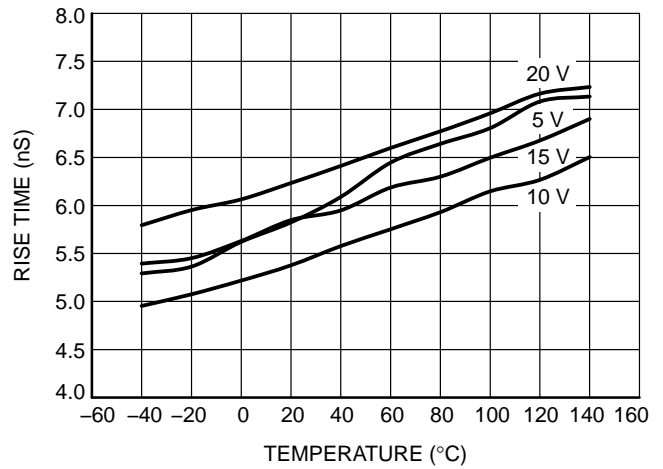

Figure 8. Rise Time vs. Temperature
 $C_{load} = 1.8\text{ nF}$

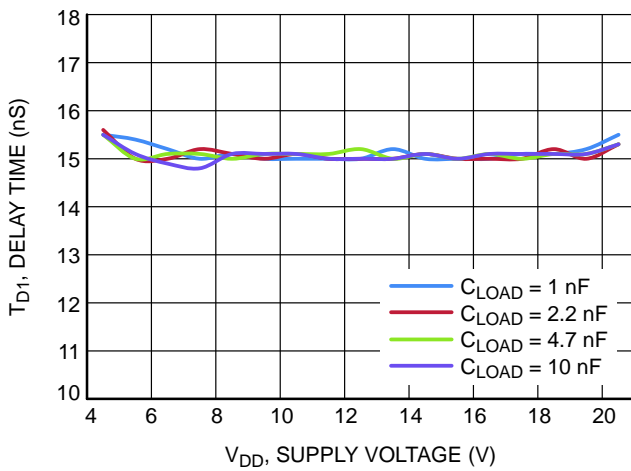

Figure 9. Propagation Delay T_{D1} vs. Supply Voltage

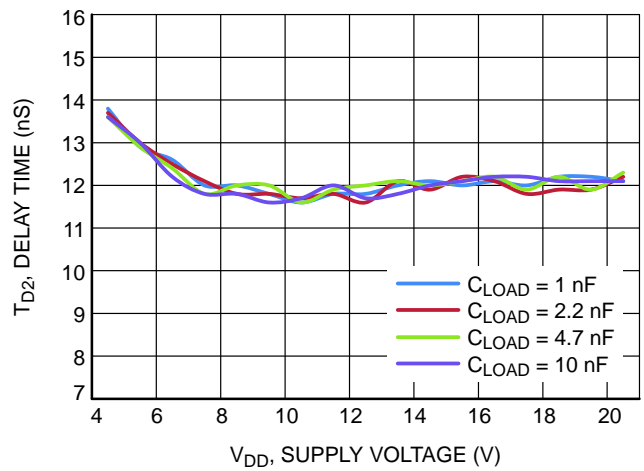

Figure 10. Propagation Delay T_{D2} vs. Supply Voltage

NCP81074A, NCP81074B

TYPICAL CHARACTERISTICS

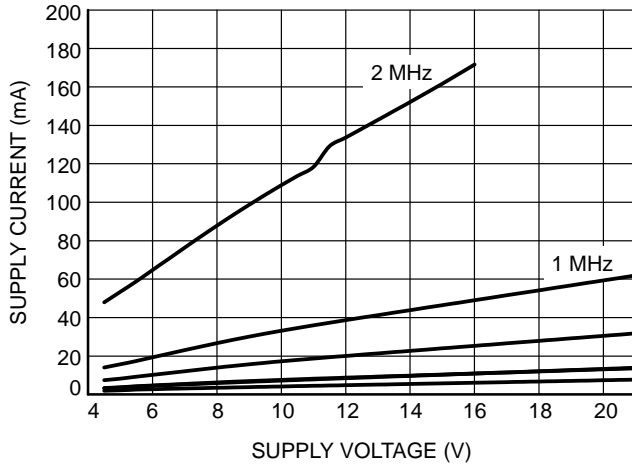

Figure 11. Supply Current vs. Supply Voltage
 $C_{LOAD} = 2.2 \text{ nF}$

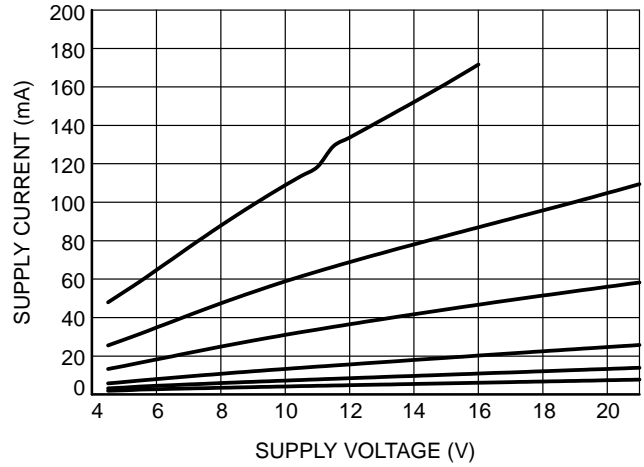

Figure 12. Supply Current vs. Supply Voltage
 $C_{LOAD} = 4.7 \text{ nF}$

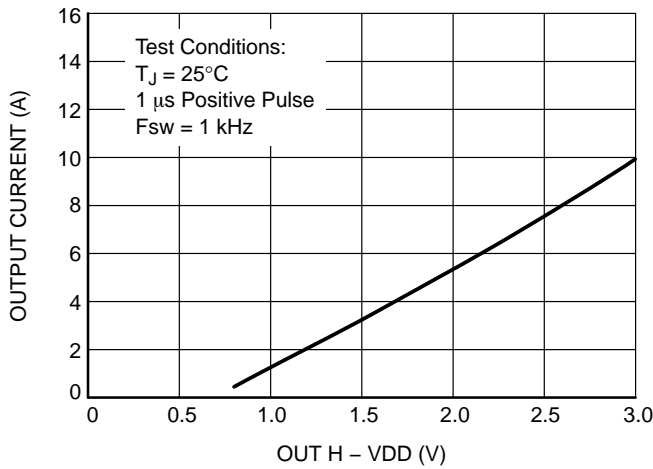

Figure 13. Reverse Current, $P_{MOS(on)}$, $P_{MOS(off)}$

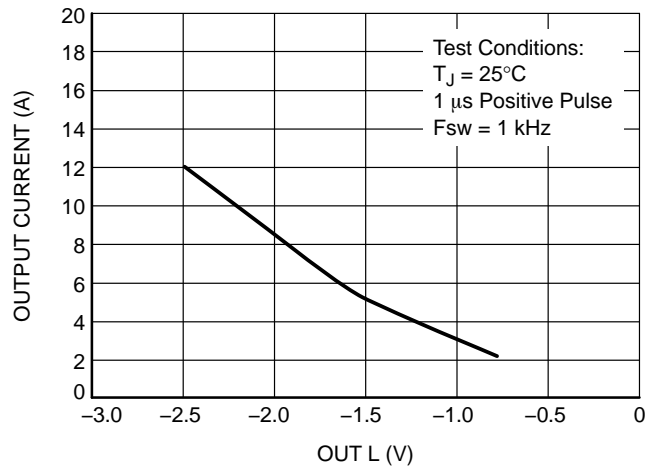

Figure 14. Reverse Current, $P_{MOS(off)}$, $P_{MOS(on)}$

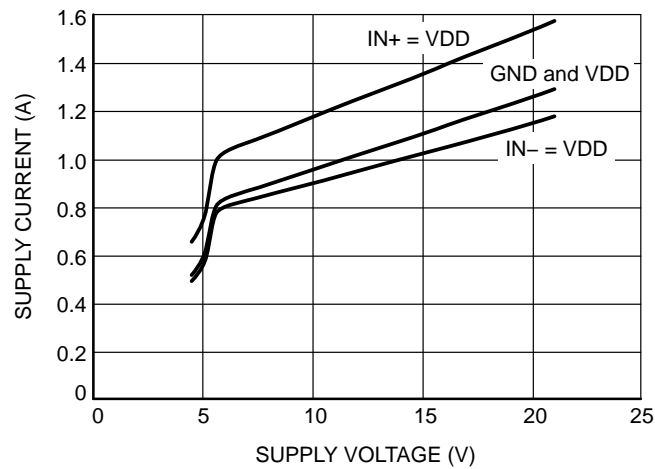

Figure 15. Supply Current vs. Supply Voltage

NCP81074A, NCP81074B

BENCH WAVEFORMS – Non-Inverting Input

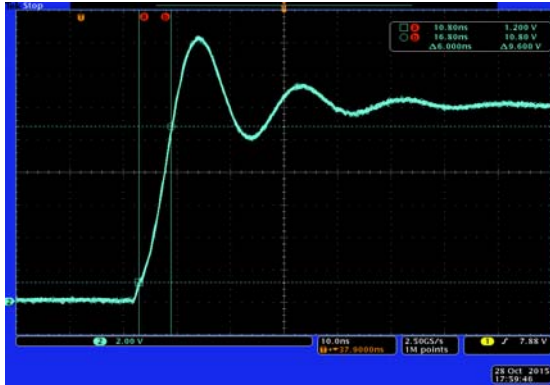

Figure 16. Rise Time with 1.8 nF Load

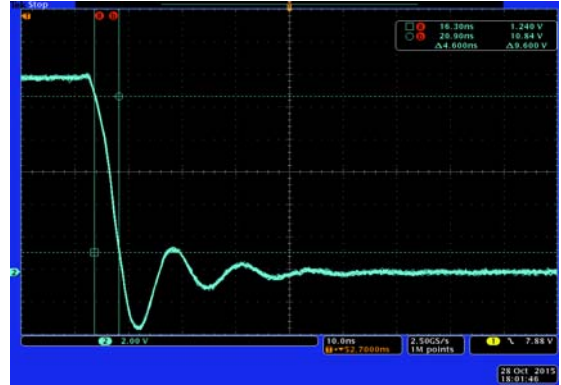

Figure 17. Fall Time with 1.8 nF Load

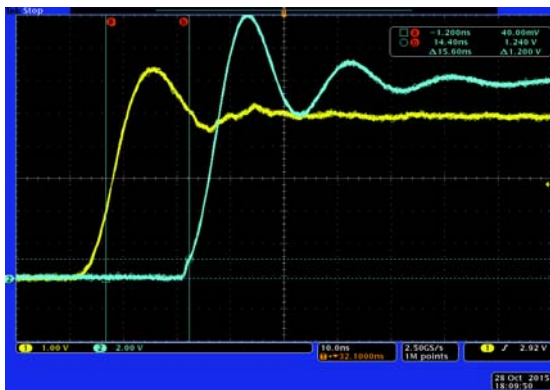

Figure 18. Propagation Delays with 1.8 nF Load

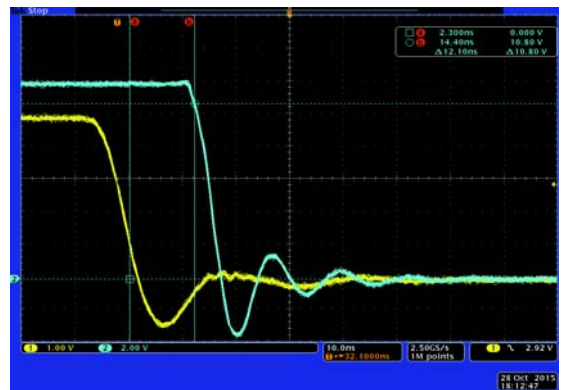

Figure 19. Propagation Delays with 1.8 nF Load

NCP81074A, NCP81074B

BENCH WAVEFORMS – Inverting Input

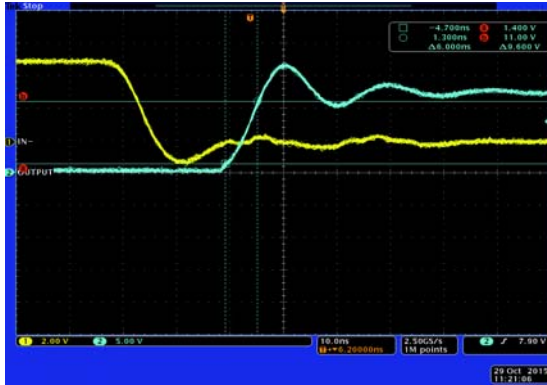

Figure 20. Rise Time with 1.8 nF Load

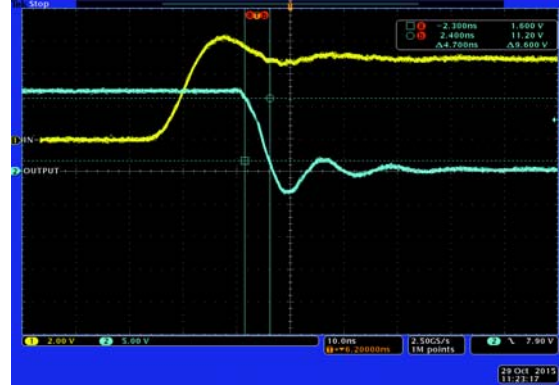

Figure 21. Fall Time with 1.8 nF Load



Figure 22. Propagation Delays with 1.8 nF Load

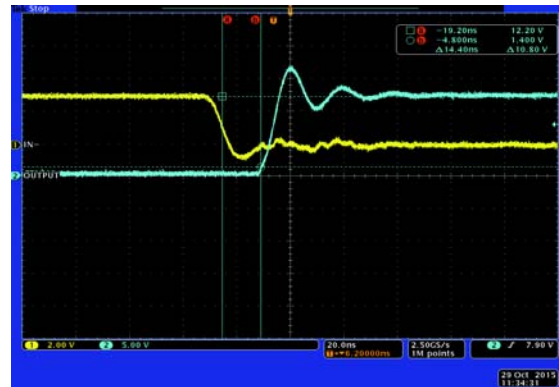

Figure 23. Propagation Delays with 1.8 nF Load

NCP81074A, NCP81074B

PCB LAYOUT RECOMMENDATION

Proper component placement is extremely important in high current, fast switching applications to provide appropriate device operation and design robustness. The NCP81074 gate driver exhibits a powerful output stage enabling large peak currents with fast rise and fall times. Eventhough the NCP81074 provides a split output configuration for slew rate control, a proper PCB layout is crucial to ensure maximum performance. The following circuit layout guidelines are strongly recommended when designing with the NCP81074.

- Place the driver close to the power MOSFET in order to have a low impedance path between the output pins and the gate. Keep the traces short and wide to minimize the parasitic inductance and accommodate for high peak currents.
- Place the decoupling capacitor close to the gate drive IC. Placing the VDD capacitor close to the pin and ground improves noise filtering. This capacitor supplies

high peak currents during the turn-on transition of the MOSFET. Using a low ESL chip capacitor is highly recommended.

- Keep a tight turn-on turn-off current loop paths to minimize parasitic inductance. High di/dt will induce voltage spikes on the output pin and the MOSFET gate. Parallel the source and return signals taking advantage of flux cancellation.
- Since the NCP81074 is a 2x2mm package driving high peak currents into capacitive loads, adding a shielding ground plane helps in power dissipation and noise blocking. The ground plane should not be a current carrying path to any of the current loops.
- Any unused pin, should be pulled to either rail depending on the functionality of the pin to avoid any malfunction on the output. Please refer to the pin description table for more information.

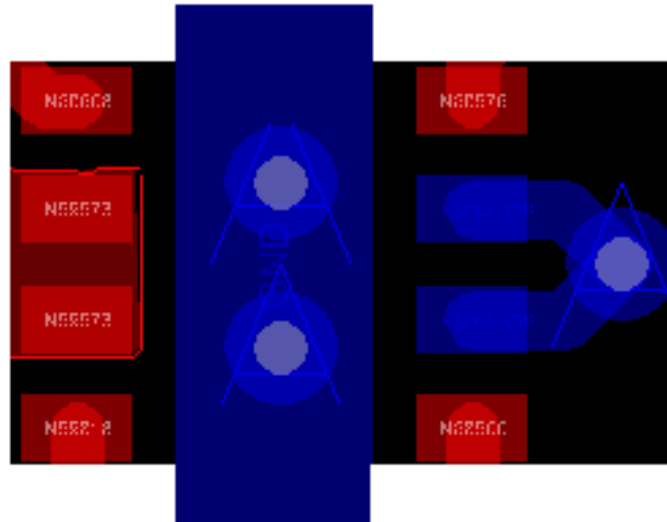
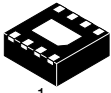

Figure 24.

MECHANICAL CASE OUTLINE

PACKAGE DIMENSIONS

ON Semiconductor®



SCALE 4:1

DFN8 2x2, 0.5P
CASE 506AA-01
ISSUE E

DATE 22 JAN 2010

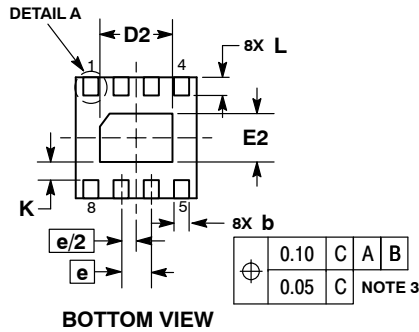
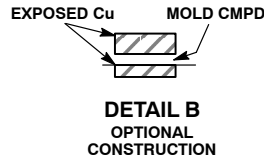
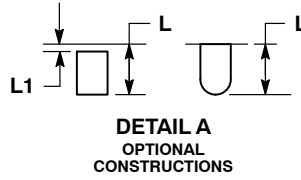
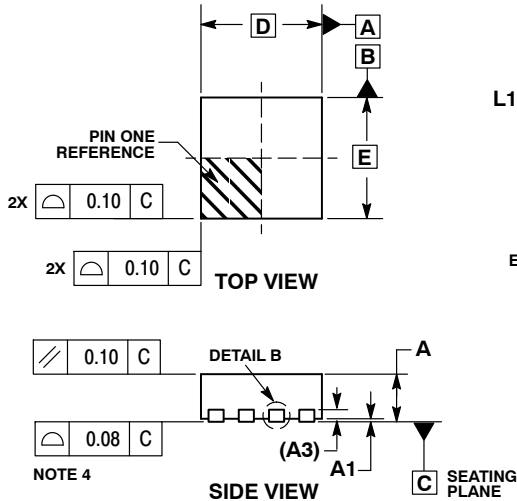

NOTES:

1. DIMENSIONING AND TOLERANCING PER ASME Y14.5M, 1994.
2. CONTROLLING DIMENSION: MILLIMETERS.
3. DIMENSION b APPLIES TO PLATED TERMINAL AND IS MEASURED BETWEEN 0.15 AND 0.20 MM FROM TERMINAL TIP.
4. COPLANARITY APPLIES TO THE EXPOSED PAD AS WELL AS THE TERMINALS.

DIM	MILLIMETERS	
	MIN	MAX
A	0.80	1.00
A1	0.00	0.05
A3	0.20	REF
b	0.20	0.30
D	2.00	BSC
D2	1.10	1.30
E	2.00	BSC
E2	0.70	0.90
e	0.50	BSC
K	0.30	REF
L	0.25	0.35
L1	---	0.10

GENERIC MARKING DIAGRAM*

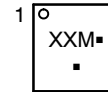

- XX = Specific Device Code
- M = Date Code
- = Pb-Free Device

*This information is generic. Please refer to device data sheet for actual part marking. Pb-Free indicator, "G" or microdot "■", may or may not be present.

RECOMMENDED SOLDERING FOOTPRINT*

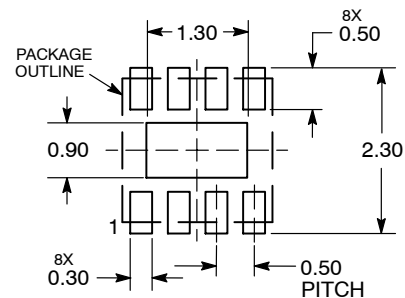

DIMENSIONS: MILLIMETERS

*For additional information on our Pb-Free strategy and soldering details, please download the ON Semiconductor Soldering and Mounting Techniques Reference Manual, SOLDERRM/D.

DOCUMENT NUMBER:	98AON18658D	Electronic versions are uncontrolled except when accessed directly from the Document Repository. Printed versions are uncontrolled except when stamped "CONTROLLED COPY" in red.
DESCRIPTION:	DFN8, 2.0X2.0, 0.5MM PITCH	PAGE 1 OF 1

ON Semiconductor and are trademarks of Semiconductor Components Industries, LLC dba ON Semiconductor or its subsidiaries in the United States and/or other countries. ON Semiconductor reserves the right to make changes without further notice to any products herein. ON Semiconductor makes no warranty, representation or guarantee regarding the suitability of its products for any particular purpose, nor does ON Semiconductor assume any liability arising out of the application or use of any product or circuit, and specifically disclaims any and all liability, including without limitation special, consequential or incidental damages. ON Semiconductor does not convey any license under its patent rights nor the rights of others.

MECHANICAL CASE OUTLINE PACKAGE DIMENSIONS

ON Semiconductor®



SCALE 1:1

SOIC-8 NB
CASE 751-07
ISSUE AK

DATE 16 FEB 2011



- NOTES:
1. DIMENSIONING AND TOLERANCING PER ANSI Y14.5M, 1982.
 2. CONTROLLING DIMENSION: MILLIMETER.
 3. DIMENSION A AND B DO NOT INCLUDE MOLD PROTRUSION.
 4. MAXIMUM MOLD PROTRUSION 0.15 (0.006) PER SIDE.
 5. DIMENSION D DOES NOT INCLUDE DAMBAR PROTRUSION. ALLOWABLE DAMBAR PROTRUSION SHALL BE 0.127 (0.005) TOTAL IN EXCESS OF THE D DIMENSION AT MAXIMUM MATERIAL CONDITION.
 6. 751-01 THRU 751-06 ARE OBSOLETE. NEW STANDARD IS 751-07.

DIM	MILLIMETERS		INCHES	
	MIN	MAX	MIN	MAX
A	4.80	5.00	0.189	0.197
B	3.80	4.00	0.150	0.157
C	1.35	1.75	0.053	0.069
D	0.33	0.51	0.013	0.020
G	1.27 BSC		0.050 BSC	
H	0.10	0.25	0.004	0.010
J	0.19	0.25	0.007	0.010
K	0.40	1.27	0.016	0.050
M	0°	8°	0°	8°
N	0.25	0.50	0.010	0.020
S	5.80	6.20	0.228	0.244

SOLDERING FOOTPRINT*



*For additional information on our Pb-Free strategy and soldering details, please download the ON Semiconductor Soldering and Mounting Techniques Reference Manual, SOLDERRM/D.

GENERIC MARKING DIAGRAM*



XXXXXX = Specific Device Code
 A = Assembly Location
 L = Wafer Lot
 Y = Year
 W = Work Week
 ■ = Pb-Free Package

XXXXXX = Specific Device Code
 A = Assembly Location
 Y = Year
 WW = Work Week
 ■ = Pb-Free Package

*This information is generic. Please refer to device data sheet for actual part marking. Pb-Free indicator, "G" or microdot "•", may or may not be present. Some products may not follow the Generic Marking.

STYLES ON PAGE 2

DOCUMENT NUMBER:	98ASB42564B	Electronic versions are uncontrolled except when accessed directly from the Document Repository. Printed versions are uncontrolled except when stamped "CONTROLLED COPY" in red.
DESCRIPTION:	SOIC-8 NB	PAGE 1 OF 2

ON Semiconductor and ON are trademarks of Semiconductor Components Industries, LLC dba ON Semiconductor or its subsidiaries in the United States and/or other countries. ON Semiconductor reserves the right to make changes without further notice to any products herein. ON Semiconductor makes no warranty, representation or guarantee regarding the suitability of its products for any particular purpose, nor does ON Semiconductor assume any liability arising out of the application or use of any product or circuit, and specifically disclaims any and all liability, including without limitation special, consequential or incidental damages. ON Semiconductor does not convey any license under its patent rights nor the rights of others.

SOIC-8 NB
CASE 751-07
ISSUE AK

DATE 16 FEB 2011

- | | | | |
|--|---|---|---|
| <p>STYLE 1:
 PIN 1. EMITTER
 2. COLLECTOR
 3. COLLECTOR
 4. EMITTER
 5. EMITTER
 6. BASE
 7. BASE
 8. EMITTER</p> | <p>STYLE 2:
 PIN 1. COLLECTOR, DIE, #1
 2. COLLECTOR, #1
 3. COLLECTOR, #2
 4. COLLECTOR, #2
 5. BASE, #2
 6. EMITTER, #2
 7. BASE, #1
 8. EMITTER, #1</p> | <p>STYLE 3:
 PIN 1. DRAIN, DIE #1
 2. DRAIN, #1
 3. DRAIN, #2
 4. DRAIN, #2
 5. GATE, #2
 6. SOURCE, #2
 7. GATE, #1
 8. SOURCE, #1</p> | <p>STYLE 4:
 PIN 1. ANODE
 2. ANODE
 3. ANODE
 4. ANODE
 5. ANODE
 6. ANODE
 7. ANODE
 8. COMMON CATHODE</p> |
| <p>STYLE 5:
 PIN 1. DRAIN
 2. DRAIN
 3. DRAIN
 4. DRAIN
 5. GATE
 6. GATE
 7. SOURCE
 8. SOURCE</p> | <p>STYLE 6:
 PIN 1. SOURCE
 2. DRAIN
 3. DRAIN
 4. SOURCE
 5. SOURCE
 6. GATE
 7. GATE
 8. SOURCE</p> | <p>STYLE 7:
 PIN 1. INPUT
 2. EXTERNAL BYPASS
 3. THIRD STAGE SOURCE
 4. GROUND
 5. DRAIN
 6. GATE 3
 7. SECOND STAGE Vd
 8. FIRST STAGE Vd</p> | <p>STYLE 8:
 PIN 1. COLLECTOR, DIE #1
 2. BASE, #1
 3. BASE, #2
 4. COLLECTOR, #2
 5. COLLECTOR, #2
 6. EMITTER, #2
 7. EMITTER, #1
 8. COLLECTOR, #1</p> |
| <p>STYLE 9:
 PIN 1. EMITTER, COMMON
 2. COLLECTOR, DIE #1
 3. COLLECTOR, DIE #2
 4. EMITTER, COMMON
 5. EMITTER, COMMON
 6. BASE, DIE #2
 7. BASE, DIE #1
 8. EMITTER, COMMON</p> | <p>STYLE 10:
 PIN 1. GROUND
 2. BIAS 1
 3. OUTPUT
 4. GROUND
 5. GROUND
 6. BIAS 2
 7. INPUT
 8. GROUND</p> | <p>STYLE 11:
 PIN 1. SOURCE 1
 2. GATE 1
 3. SOURCE 2
 4. GATE 2
 5. DRAIN 2
 6. DRAIN 2
 7. DRAIN 1
 8. DRAIN 1</p> | <p>STYLE 12:
 PIN 1. SOURCE
 2. SOURCE
 3. SOURCE
 4. GATE
 5. DRAIN
 6. DRAIN
 7. DRAIN
 8. DRAIN</p> |
| <p>STYLE 13:
 PIN 1. N.C.
 2. SOURCE
 3. SOURCE
 4. GATE
 5. DRAIN
 6. DRAIN
 7. DRAIN
 8. DRAIN</p> | <p>STYLE 14:
 PIN 1. N-SOURCE
 2. N-GATE
 3. P-SOURCE
 4. P-GATE
 5. P-DRAIN
 6. P-DRAIN
 7. N-DRAIN
 8. N-DRAIN</p> | <p>STYLE 15:
 PIN 1. ANODE 1
 2. ANODE 1
 3. ANODE 1
 4. ANODE 1
 5. CATHODE, COMMON
 6. CATHODE, COMMON
 7. CATHODE, COMMON
 8. CATHODE, COMMON</p> | <p>STYLE 16:
 PIN 1. EMITTER, DIE #1
 2. BASE, DIE #1
 3. EMITTER, DIE #2
 4. BASE, DIE #2
 5. COLLECTOR, DIE #2
 6. COLLECTOR, DIE #2
 7. COLLECTOR, DIE #1
 8. COLLECTOR, DIE #1</p> |
| <p>STYLE 17:
 PIN 1. VCC
 2. V2OUT
 3. V1OUT
 4. TXE
 5. RXE
 6. VEE
 7. GND
 8. ACC</p> | <p>STYLE 18:
 PIN 1. ANODE
 2. ANODE
 3. SOURCE
 4. GATE
 5. DRAIN
 6. DRAIN
 7. CATHODE
 8. CATHODE</p> | <p>STYLE 19:
 PIN 1. SOURCE 1
 2. GATE 1
 3. SOURCE 2
 4. GATE 2
 5. DRAIN 2
 6. MIRROR 2
 7. DRAIN 1
 8. MIRROR 1</p> | <p>STYLE 20:
 PIN 1. SOURCE (N)
 2. GATE (N)
 3. SOURCE (P)
 4. GATE (P)
 5. DRAIN
 6. DRAIN
 7. DRAIN
 8. DRAIN</p> |
| <p>STYLE 21:
 PIN 1. CATHODE 1
 2. CATHODE 2
 3. CATHODE 3
 4. CATHODE 4
 5. CATHODE 5
 6. COMMON ANODE
 7. COMMON ANODE
 8. CATHODE 6</p> | <p>STYLE 22:
 PIN 1. I/O LINE 1
 2. COMMON CATHODE/VCC
 3. COMMON CATHODE/VCC
 4. I/O LINE 3
 5. COMMON ANODE/GND
 6. I/O LINE 4
 7. I/O LINE 5
 8. COMMON ANODE/GND</p> | <p>STYLE 23:
 PIN 1. LINE 1 IN
 2. COMMON ANODE/GND
 3. COMMON ANODE/GND
 4. LINE 2 IN
 5. LINE 2 OUT
 6. COMMON ANODE/GND
 7. COMMON ANODE/GND
 8. LINE 1 OUT</p> | <p>STYLE 24:
 PIN 1. BASE
 2. EMITTER
 3. COLLECTOR/ANODE
 4. COLLECTOR/ANODE
 5. CATHODE
 6. CATHODE
 7. COLLECTOR/ANODE
 8. COLLECTOR/ANODE</p> |
| <p>STYLE 25:
 PIN 1. VIN
 2. N/C
 3. REXT
 4. GND
 5. IOUT
 6. IOUT
 7. IOUT
 8. IOUT</p> | <p>STYLE 26:
 PIN 1. GND
 2. dv/dt
 3. ENABLE
 4. ILIMIT
 5. SOURCE
 6. SOURCE
 7. SOURCE
 8. VCC</p> | <p>STYLE 27:
 PIN 1. ILIMIT
 2. OVLO
 3. UVLO
 4. INPUT+
 5. SOURCE
 6. SOURCE
 7. SOURCE
 8. DRAIN</p> | <p>STYLE 28:
 PIN 1. SW_TO_GND
 2. DASIC OFF
 3. DASIC_SW_DET
 4. GND
 5. V_MON
 6. VBULK
 7. VBULK
 8. VIN</p> |
| <p>STYLE 29:
 PIN 1. BASE, DIE #1
 2. EMITTER, #1
 3. BASE, #2
 4. EMITTER, #2
 5. COLLECTOR, #2
 6. COLLECTOR, #2
 7. COLLECTOR, #1
 8. COLLECTOR, #1</p> | <p>STYLE 30:
 PIN 1. DRAIN 1
 2. DRAIN 1
 3. GATE 2
 4. SOURCE 2
 5. SOURCE 1/DRAIN 2
 6. SOURCE 1/DRAIN 2
 7. SOURCE 1/DRAIN 2
 8. GATE 1</p> | | |

DOCUMENT NUMBER:	98ASB42564B	Electronic versions are uncontrolled except when accessed directly from the Document Repository. Printed versions are uncontrolled except when stamped "CONTROLLED COPY" in red.
DESCRIPTION:	SOIC-8 NB	PAGE 2 OF 2

ON Semiconductor and  are trademarks of Semiconductor Components Industries, LLC dba ON Semiconductor or its subsidiaries in the United States and/or other countries. ON Semiconductor reserves the right to make changes without further notice to any products herein. ON Semiconductor makes no warranty, representation or guarantee regarding the suitability of its products for any particular purpose, nor does ON Semiconductor assume any liability arising out of the application or use of any product or circuit, and specifically disclaims any and all liability, including without limitation special, consequential or incidental damages. ON Semiconductor does not convey any license under its patent rights nor the rights of others.

onsemi, **Onsemi**, and other names, marks, and brands are registered and/or common law trademarks of Semiconductor Components Industries, LLC dba "**onsemi**" or its affiliates and/or subsidiaries in the United States and/or other countries. **onsemi** owns the rights to a number of patents, trademarks, copyrights, trade secrets, and other intellectual property. A listing of **onsemi**'s product/patent coverage may be accessed at www.onsemi.com/site/pdf/Patent-Marking.pdf. **onsemi** reserves the right to make changes at any time to any products or information herein, without notice. The information herein is provided "as-is" and **onsemi** makes no warranty, representation or guarantee regarding the accuracy of the information, product features, availability, functionality, or suitability of its products for any particular purpose, nor does **onsemi** assume any liability arising out of the application or use of any product or circuit, and specifically disclaims any and all liability, including without limitation special, consequential or incidental damages. Buyer is responsible for its products and applications using **onsemi** products, including compliance with all laws, regulations and safety requirements or standards, regardless of any support or applications information provided by **onsemi**. "Typical" parameters which may be provided in **onsemi** data sheets and/or specifications can and do vary in different applications and actual performance may vary over time. All operating parameters, including "Typicals" must be validated for each customer application by customer's technical experts. **onsemi** does not convey any license under any of its intellectual property rights nor the rights of others. **onsemi** products are not designed, intended, or authorized for use as a critical component in life support systems or any FDA Class 3 medical devices or medical devices with a same or similar classification in a foreign jurisdiction or any devices intended for implantation in the human body. Should Buyer purchase or use **onsemi** products for any such unintended or unauthorized application, Buyer shall indemnify and hold **onsemi** and its officers, employees, subsidiaries, affiliates, and distributors harmless against all claims, costs, damages, and expenses, and reasonable attorney fees arising out of, directly or indirectly, any claim of personal injury or death associated with such unintended or unauthorized use, even if such claim alleges that **onsemi** was negligent regarding the design or manufacture of the part. **onsemi** is an Equal Opportunity/Affirmative Action Employer. This literature is subject to all applicable copyright laws and is not for resale in any manner.

PUBLICATION ORDERING INFORMATION

LITERATURE FULFILLMENT:

Email Requests to: orderlit@onsemi.com

onsemi Website: www.onsemi.com

TECHNICAL SUPPORT

North American Technical Support:

Voice Mail: 1 800-282-9855 Toll Free USA/Canada

Phone: 011 421 33 790 2910

Europe, Middle East and Africa Technical Support:

Phone: 00421 33 790 2910

For additional information, please contact your local Sales Representative